

SECTIONAL ELEVATION

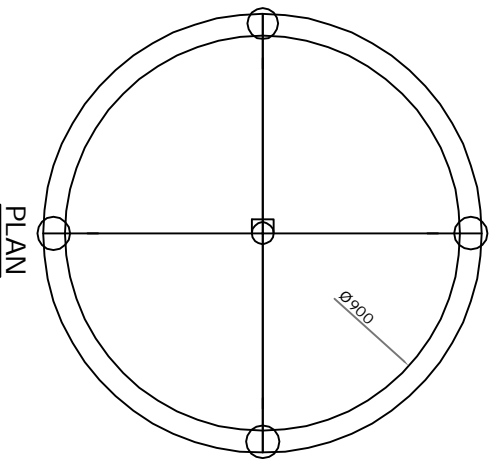

PLAN

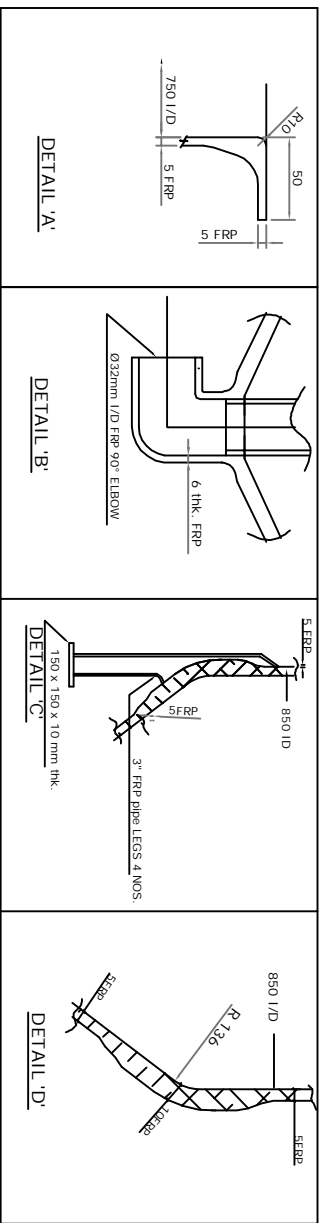

REFERENCE



01.	DIMENSIONS	All in M.M.
02.	TANK SHAPE	CONICAL
03.	QUANTITY	10 NOS.
04.	MATERIAL OF CONSTRUCTION	FRP. (FOOD GRADE)
05.	TANK SIZE	900 TOP, 850 BOTTOM (I/D)
06.	COLLECTION TANK SIZE	850 TOP, 32 BOTTOM (I/D)
07.	WALL THICKNESS	5 MM
08.	RIB SIZE	50 (ALL ROUND WITH NOSING)
09.	OUTSIDE SURFACE PIGMENT	GRAY / WHITE
10.	INSIDE SURFACE PIGMENT	WHITE
11.	CAPACITY	500 LIT
12.	REINFORCEMENT	FRP
RAJIV GANDHI CENTRE FOR AQUACULTURE (RGCA)		
PROJECT : SEABASS & MUD CRAB HATCHERY PROJECT		
TITLE : - ARTEMIA HATCHING TANKS		